

10%  
made in Italy

Medical Line

# DreaMed

Universal medicine  
*Medicina universale*



Multifunctional couch-bed  
*Poltrona-lettino multispecialistica*

**Lemi**<sup>®</sup>  
MADE IN ITALY

# Movements / Movimentazioni

ENT VISITS • DENTAL SURGERY AND IMPLANTOLOGY  
STOMATOLOGY • ORTHODONTICS • OPHTHALMOLOGY  
DIAGNOSTICS • MINOR SURGERY INTERVENTIONS

4 independent electric movements: height, back rest, trendelenburg  
1 synchronized electric movement: back rest/leg rest  
2 manual movements: rotation and leg rest extension  
Automatic reset control to bring the couch back to the initial position

Electric height  
*Altezza elettrica*  
52-82 cm  
(20"-30")



Electric Trendelenburg  
*Trendelenburg elettrico*



30°



180°

90° rotation on both sides  
*Rotazione 90° da entrambi i lati*

VISITE DI OTORINOLARINGOIATRIA • CHIRURGIA DENTALE E IMPLANTOLOGIA  
STOMATOLOGIA • ORTODONZIA • OFTALMOLOGIA  
DIAGNOSTICA • PICCOLI INTERVENTI AMBULATORIALI

DreaMed • cod. 333

4 movimenti elettrici indipendenti: altezza, schiena, gambe, trendelenburg  
1 movimento elettrico sincronizzato: schiena/gambe  
2 movimenti manuali: rotazione ed estensione gambe  
Comando di azzeramento automatico che riporta il letto nella posizione base

Synchronized back rest/leg  
rest movement

Movimentazione sincronizzata  
schiena/gambe

Electric leg rest  
Gambe elettriche



Electric back rest  
Schiena elettrica



3 motors version cod. 330

3 manual movements:  
rotation, leg rest inclination and extension

Versione 3 motori cod. 330

3 movimenti manuali:  
rotazione, inclinazione ed estensione gambe

ENT VISITS • DENTAL SURGERY AND IMPLANTOLOGY  
STOMATOLOGY • ORTHODONTICS • OPHTHALMOLOGY  
DIAGNOSTICS • MINOR SURGERY INTERVENTIONS



Easy-to-clean anatomic  
mattress without stitching

*Materasso anatomico  
senza cuciture per una  
facile igienizzazione*

Its complete ABS covering  
grants elegance and safety  
while protecting the inner  
components from liquids

*Completamente chiuso con  
carter in ABS garantisce  
alla poltrona eleganza e  
sicurezza, proteggendo i  
componenti interni dai liquidi*

2 adjustable small feet  
under the base

*2 piedini regolabili  
alla base*

Wide choice of upholsteries  
available on stock

*Ampia scelta di rivestimenti  
disponibili a stock*

Maximum load weight  
without risk 200 kg

*Portata max in sicurezza  
200 kg*

Predisposition for medical  
accessories to adapt the  
couch to any purpose

*Predisposizione accessori  
medicali per adattare la  
poltrona ad ogni utilizzo*

4 electric actuators current  
continuous 24V cc

*4 motori elettrici 24V cc  
a regolazione continua*

Foot pedal control with  
automatic reset to zero

*Pedaliera con azzeramento  
automatico*



### Technical specifications

Minimum height: 52 cm - 20"  
Maximum height: 82 cm - 32"  
Angle of inclination trendelenburg: 30°  
Angle of inclination back rest: 80°  
Angle of inclination leg rest: 90°  
Mattress length: 168 cm - 66"  
Mattress length (with extended leg rest):  
185 cm - 73"  
Mattress width: 59 cm - 23"  
Rotation: 90° on both sides  
Latex-free, non-toxic and non-carcinogenic  
materials  
Fire-resistant upholstery: UNI 9175 class 1M

### Specifiche tecniche

*Altezza minima: 52 cm*  
*Altezza massima: 82 cm*  
*Angolo inclinazione trendelenburg: 30°*  
*Angolo inclinazione schiena: 80°*  
*Angolo inclinazione gambe: 90°*  
*Lunghezza materasso: 168 cm*  
*Lunghezza materasso gambe estese:  
185 cm*  
*Larghezza materasso: 59 cm*  
*Rotazione: 90° su entrambe i lati*  
*Materiali privi di lattice, atossici e non  
cancerogeni*  
*Rivestimento ignifugo: UNI 9175 class 1M*

### Electric requirements

Voltage: 230V ac, 110V ac  
Frequency: 50 Hz / 60 Hz  
Absorption: 0,70 A max  
Electric system conforms to CEI norms  
4 actuators 24V cc (thrust 6000 N)  
Class II control box 220Vac 50Hz  
Transformer 120 Va  
Class I medical device (dir. 93/42/CEE)  
Protection rating IP54  
Low-tension foot pedal control

### Packaging details

Size: 170x74x86h cm (67"x30"x34")  
Volume: 1,081 m<sup>3</sup>  
Gross weight: 92 kg - 203 lbs  
Net weight: 76 kg - 168 lbs

### Caratteristiche imballo

*Dimensioni: 170x74x86h cm*  
*Volume: 1,081 m<sup>3</sup>*  
*Peso lordo: 92 kg*  
*Peso netto: 76 kg*

### Caratteristiche elettriche

*Voltaggio: 230V ac, 110V ac*  
*Frequenza: 50 Hz*  
*Assorbimento: 0,70 A max*  
*Impianto elettrico a norme CEI*  
*4 attuatori 24V cc (spinta 6000N)*  
*Centralina in classe II 220 Vac 50Hz*  
*Trasformatore da 120 Va*  
*Disp. Medico classe I (dir. 93/42/CEE)*  
*Grado di protezione IP54*  
*Pedaliera a bassa tensione*

### Warranty

Structure: 10 years  
Motors and control: 2 years  
Cushion: 5 years

### Garanzia

*Struttura: 10 anni*  
*Motori e comandi: 2 anni*  
*Imbottitura: 5 anni*

Accessories upon request / Accessori su richiesta

The standard version includes flat armrests  
*La versione standard include i braccioli automatici*



cod. 108



cod. 316-317



cod. LEM-084



cod. GOP-012



cod. 314



cod. 318



cod. 313



cod. LEM-139



cod. 331



cod. LEM-180



cod. 319-320



cod. LEM-151

**cod. 108**

roll holder/porta rotolo

**cod. 316-317**

seat and back rest medical guide couple  
coppia guide medicali seduta e schiena

**cod. LEM-084**

hand set control / pulsantiera

**cod. GOP-012**

lamp adaptor featuring a 60 mm  
diameter column  
adattatore per supporto lampada  
completo di colonna ø60 mm

**cod. 314**

blood-sample taking armrest  
coppia braccioli da prelievo con snodo

**cod. 318**

jointed thigh support couple  
coppia reggicoscie con snodo

**cod. 313**

medical armrest couple  
coppia braccioli medicali

**cod. LEM-139**

wheels/ruote

**cod. 331**

metal tray with support/vassoio con supporto

**cod. 319-320**

fixed and rotating clamp couple  
coppia morsetti fissi girevoli











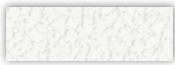
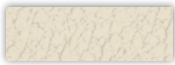
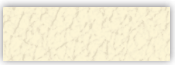
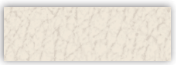
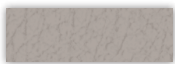
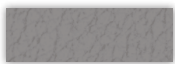
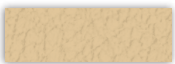
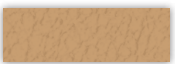
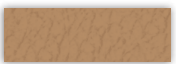
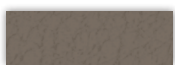



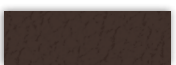

**cod. LEM-151**

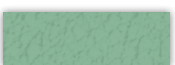
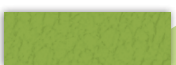
heel support couple/coppia reggi tallone

**cod. LEM-180**

pedal control/pedaliera

**Nefos Mattress colors / Colori di rivestimento Nefos**

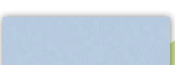
6		1155		1126		1182		1957	
6985		3962		2124		2146		1194	
6986		64		71		2173		1388	
667		680		569		1843		1868	
6942		6941		5946		6940		4942	
1305		991		G03		GB5			

**ABS covering colors / Colori carter**

**116 G**  
Light grey  
Grigio



**333 B**  
Blanc



The colors above are provided only as a guide and could be subjected to a variation due to the material different from the printed paper.

*I colori sopra riportati sono indicativi e possono essere soggetti a variazioni dovute al materiale diverso dalla carta stampata.*

Product images are for illustrative purposes only.  
The manufacturer has the right to modify pictures and descriptions  
of this catalogue at any time for commercial or technical purposes.

*L'immagine ha il solo scopo illustrativo.  
Il costruttore si riserva il diritto di effettuare le modifiche  
alle immagini e alle descrizioni di questo catalogo  
in ogni momento per esigenze di carattere  
tecnico e commerciale.*

**credits:**

photo by Studio Pi-Tre



N° 443.090.V



## Table of dimensions / *Tabella dimensionale*

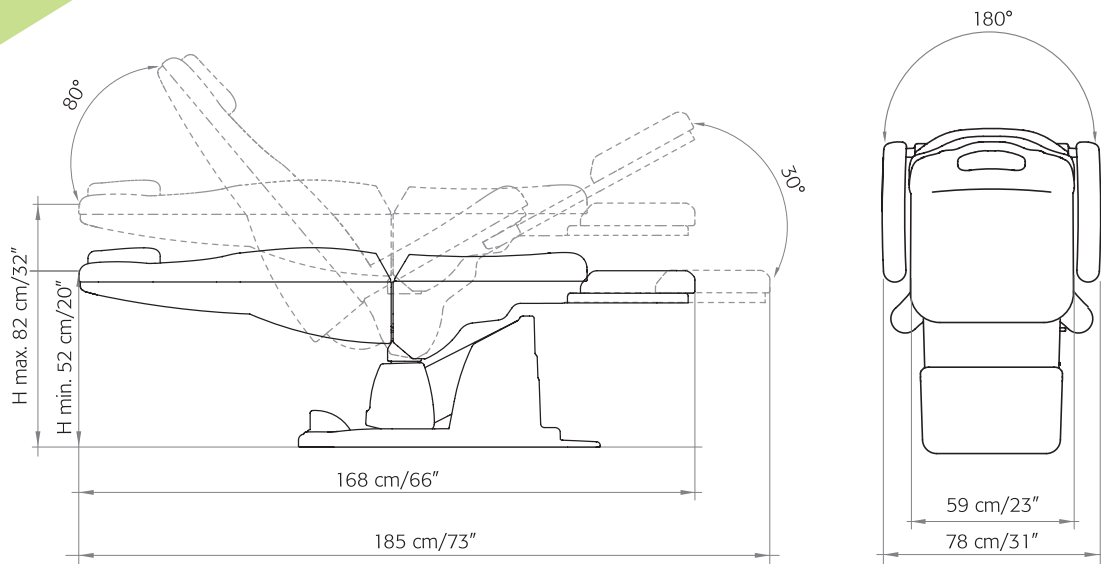

DreaMed is CE conformed and is manufactured in accordance with  
European Directives: 93/42/CE (class I); 2006/42/CE; 2004/108/CE;  
CEI EN 60204-1:2006-09; UNI EN 12100-1-2

*DreaMed è a norme CE ed è fabbricato in conformità alle seguenti Direttive  
Europee: 93/42/CE (classe I); 2006/42/CE; 2004/108/CE;  
CEI EN 60204-1:2006-09; UNI EN 12100-1-2*

### Brusaferrri & C S.r.l.

Headquarters / *Sede operativa*  
Via M. Maretti Soldi, 13 (ex S.P. n. 6)  
26011 Casalbuttano (CR) • Italy  
Tel. +39 0374 363068/69  
Fax +39 0374 363071

### LEMI SPA Beauty Equipment

Office 406 Pinnacle at Shaikh Zayed Road  
373-109 Al Barsha First • Dubai – UAE

[www.lemigroup.it](http://www.lemigroup.it) • [info@lemigroup.it](mailto:info@lemigroup.it)



**Lemi**<sup>®</sup>  
MADE IN ITALY