

100%  
made in italy

Medical Line

## Lemi 4

Over 15.000 doctors in the world  
chose Lemi ergonomics and style

*Oltre 15.000 medici nel mondo  
hanno scelto ergonomia e stile Lemi*



Multifunctional couch-bed  
*Poltrona-lettino multispecialistica*

**MEDICI-H**

**Lemi**<sup>®</sup>  
MADE IN ITALY

**MEDICI-H**  
Movements / Movimentazioni

DIAGNOSTICS • CHECK-UP • DERMATOLOGY  
AESTHETIC SURGERY • MINOR SURGERY INTERVENTIONS • CHEMIST'S  
DENTAL CLINICS • GYNECOLOGIC VISITS • BLOOD SAMPLE TAKING

4 independent electric movements: height, back rest, leg rest, trendelenburg  
1 synchronized electric movement: back rest/leg rest  
1 manual movement: head rest adjustment  
Automatic reset control to bring the couch back to the initial position

Electric height  
*Altezza elettrica*  
62-92 cm  
(24"-36")



Electric Trendelenburg  
*Trendelenburg elettrico*

4 movimenti elettrici indipendenti: altezza, schiena, gambe, trendelenburg  
1 movimento elettrico sincronizzato: schiena/gambe  
1 movimento manuale: inclinazione testa  
Comando di azzeramento automatico che riporta il letto nella posizione base

Synchronized back rest/leg rest movement

*Movimentazione sincronizzata schiena/gambe*

Electric leg rest  
*Gambe elettriche*



Adjustable head rest  
*Testa regolabile*





DIAGNOSTICS • CHECK-UP • DERMATOLOGY  
AESTHETIC SURGERY • MINOR SURGERY INTERVENTIONS • CHEMIST'S  
DENTAL CLINICS • GYNECOLOGIC VISITS • BLOOD SAMPLE TAKING

1-section flat mattress  
without stitching  
*Materasso piatto senza  
cuciture realizzato in un  
unico modulo*

Predisposition for medical  
accessories to adapt the  
couch to any purpose

*Predisposizione accessori  
medicali per adattare la  
poltrona ad ogni utilizzo*

Maximum load weight  
without risk 200 kg  
*Portata max in sicurezza  
200 kg*

Wide choice of upholsteries  
available on stock  
*Ampia scelta di rivestimenti  
disponibili a stock*

Foot pedal control with  
automatic reset to zero  
*Pulsantiera con  
azzeramento automatico*

Its complete ABS covering  
grants elegance and safety  
while protecting the inner  
components from liquids  
*Completamente chiuso con  
carter in ABS garantisce  
alla poltrona eleganza e  
sicurezza, proteggendo i  
componenti interni dai liquidi*

4 adjustable small feet under the base  
*4 piedini regolabili alla base*

4 electric continuously  
variable actuators 24V cc  
*N° 4 motori elettrici 24 V cc  
a regolazione continua*



## Technical specifications

Minimum height: 62 cm - 24"

Maximum height: 92 cm - 36"

Angle of inclination trendelenburg: 25°

Angle of inclination back rest: 75°

Angle of inclination leg rest: 65°

Angle of inclination head rest: 27°

Mattress length: 190 cm - 75"

Mattress width: 62 cm - 24"

Thickness of anatomic mattress: cm 10 - 4"

Latex-free, non-toxic and non-carcinogenic materials

Fire-resistant upholstery: UNI 9175 class 1M

## Specifiche tecniche

Altezza minima: 62 cm

Altezza massima: 92 cm

Angolo inclinazione trendelenburg: 25°

Angolo inclinazione schiena: 75°

Angolo inclinazione gambe: 65°

Angolo inclinazione testa: 27°

Lunghezza materasso: 190 cm

Larghezza materasso: 62 cm

Spessore materasso anatomico: 10 cm

Materiali privi di lattice, atossici e non cancerogeni

Rivestimento ignifugo: UNI 9175 class 1M

## Electric requirements

Voltage: 230V ac, 110V ac

Frequency: 50 Hz / 60 Hz

Absorption: 0,70 A max

Electric system conforms to CEI norms

4 actuators 24V cc (thrust 6000 N)

Class II control box 220Vac 50Hz

Transformer 120 Va

Class I medical device (dir. 93/42/CEE)

Protection rating IP54

Low-tension 11- switch hand set control

## Packaging details

Size: 170x74x86h cm (67"x30"x34")

Volume: 1,081 m<sup>3</sup>

Gross weight: 89 kg - 196 lbs

Net weight: 73 kg - 161 lbs

## Caratteristiche imballo

Dimensioni: 170x74x86h cm

Volume: 1,081 m<sup>3</sup>

Peso lordo: 89 kg

Peso netto: 73 kg

## Caratteristiche elettriche

Voltaggio: 230V ac, 110V ac

Frequenza: 50 Hz

Assorbimento: 0,70 A max

Impianto elettrico a norme CEI

4 attuatori 24V cc (spinta 6000N)

Centralina in classe II 220 Vac 50Hz

Trasformatore da 120 Va

Disp. Medico classe I (dir. 93/42/CEE)

Grado di protezione IP54

Pulsantiera a 11 tasti a bassa tensione

## Warranty

Structure: 10 years

Motors and control: 2 years

Cushion: 5 years

Heating: 1 year

## Garanzia

Struttura: 10 anni

Motori e comandi: 2 anni

Imbottitura: 5 anni

Riscaldamento: 1 anno

**MEDICI-H**  
 Accessories upon request / Accessori su richiesta



cod. 108



cod. 111



cod. 111P



cod. 180 L



cod. 109



cod. 107



cod. 112 a

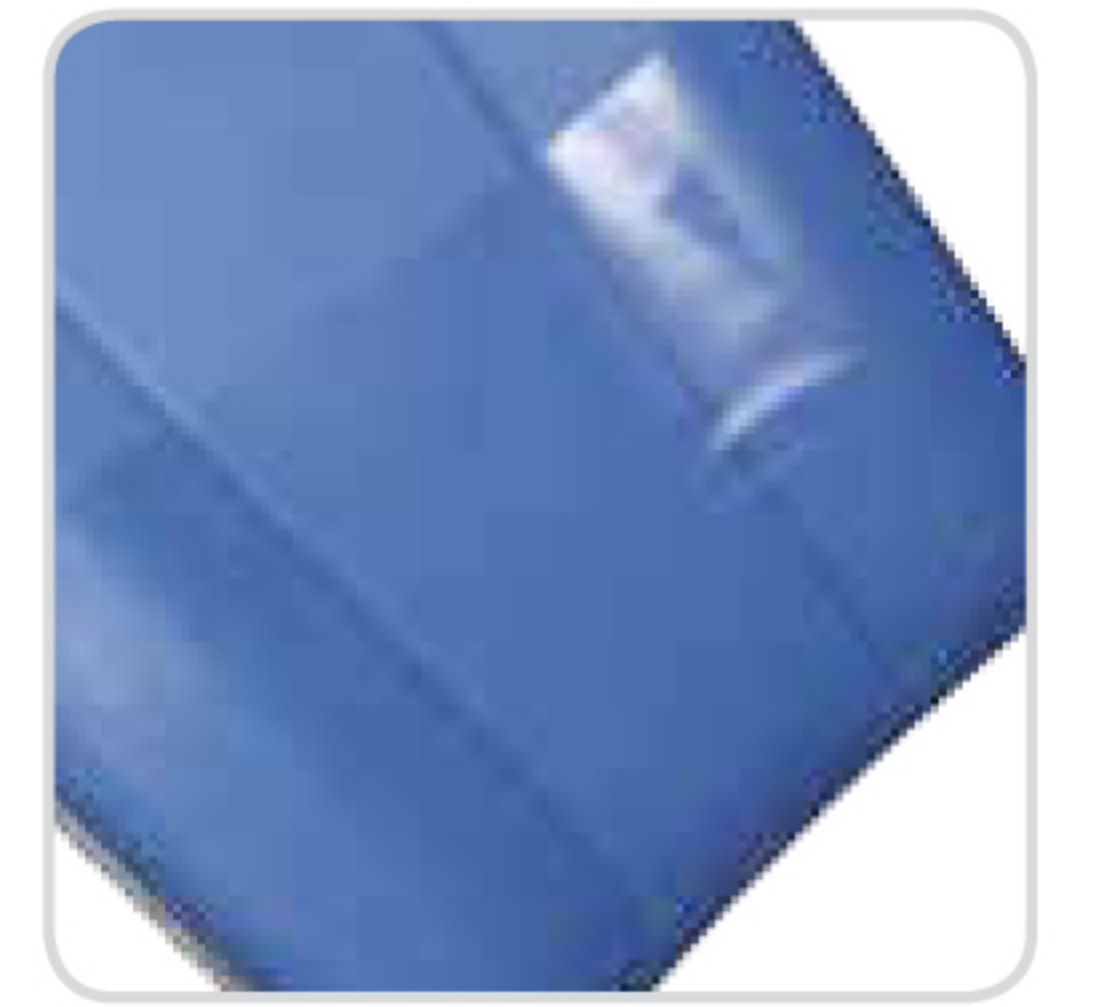

cod. Prot. gambe



cod. 331



cod. 319-320



cod. LEM-151



cod. LEM-139



cod. LEM-067



cod. 318



cod. 313



cod. 314



cod. 316-317

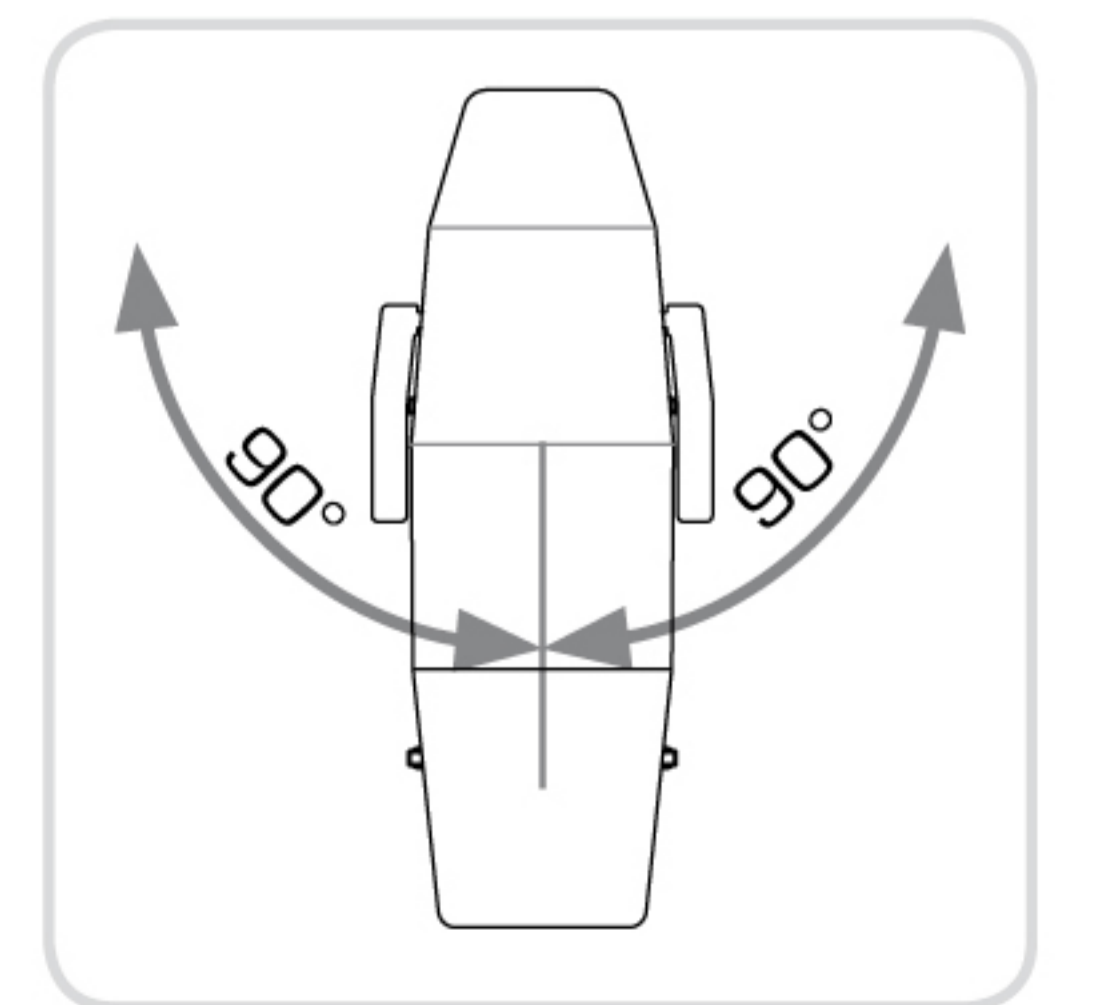

cod. ROT

**cod. 108**roll holder/*porta rotolo***cod. 111**big Zak head rest/*testa Zak grande***cod. 111P**small Zak head rest/*testa Zak piccola***cod. 180 L**seat and backrest heating  
*riscaldamento seduta e schiena***cod. 109**anatomic mattress w/out stitching  
*materasso anatomico senza cuciture***cod. 107**flat armrest couple  
*coppia braccioli automatici***cod. 112 a**american head rest with face hole  
*testa americana***cod. Prot. gambe**plastic cover for leg rest/*proteggi gambe***cod. 331**metal tray with support/*vassoio con supporto***cod. 313**medical armrest couple  
*coppia braccioli medicali***cod. 314**blood-sample taking armrest  
*coppia braccioli da prelievo con snodo***cod. 318**jointed thigh support couple  
*coppia reggicose con snodo***cod. 319-320**fixed and rotating clamp couple  
*coppia morsetti fissi girevoli***cod. LEM-151**heel support couple/*coppia reggi tallone***cod. LEM-139**wheels/*ruote***cod. LEM-067**foot pedal control / *pedaliera***cod. 316-317**seat and back rest medical guide couple  
*coppia guide medicali seduta e schiena***cod. ROT**rotation 180° / *rotazione 180°***Mattress colors / Colori materasso****P35**

Bianco

**B41**

Grigio

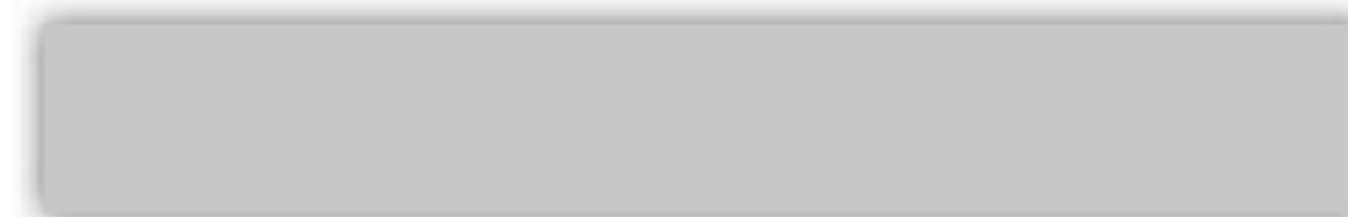
**B99**

Nero

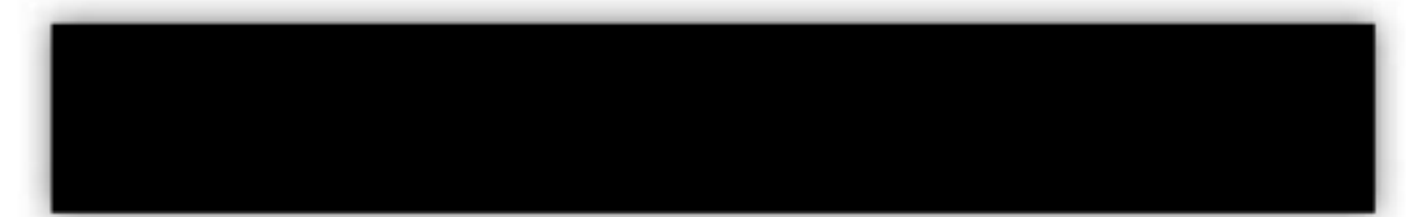
**D02**

Crema

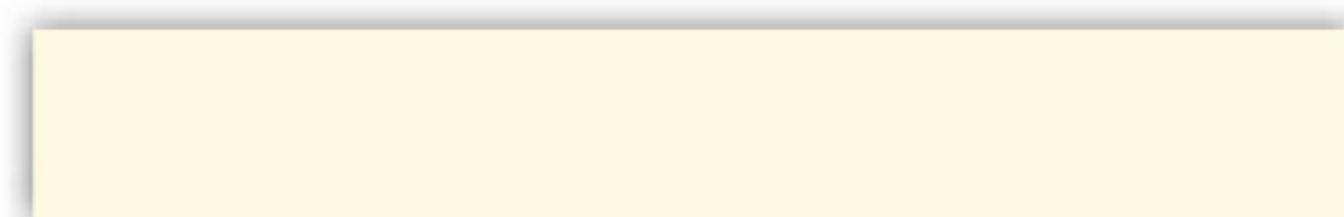
**G10**

Blu

**H98**

Viola

**G03**

Azzurro

**EB1**

Verde

**E16**

Marrone

**G85**

Cielo

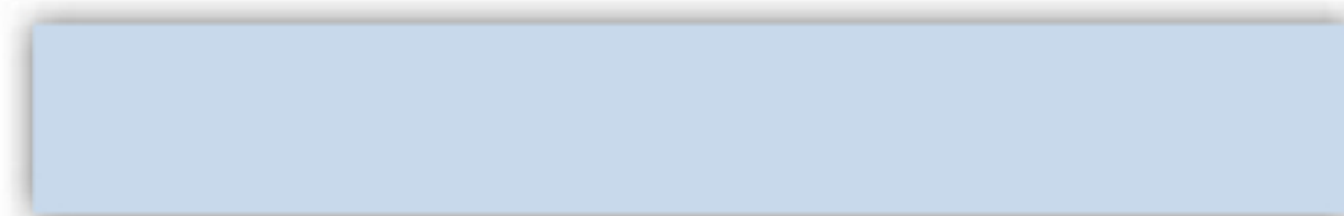
**N31**

Arancio

**Q73**

Mais

**ABS covering colors/ Colori carter****105 G**Light grey  
*Grigio***105 N**Black  
*Nero***105 B**White  
*Bianco*

The colors above are provided only as a guide and could be subjected to a variation due to the material different from the printed paper.

*I colori sopra riportati sono indicativi e possono essere soggetti a variazioni dovute al materiale diverso dalla carta stampata.*

Product images are for illustrative purposes only.  
The manufacturer has the right to modify pictures and descriptions  
of this catalogue at any time for commercial or technical purposes.

*L'immagine ha il solo scopo illustrativo.  
Il costruttore si riserva il diritto di effettuare le modifiche  
alle immagini e alle descrizioni di questo catalogo  
in ogni momento per esigenze di carattere  
tecnico e commerciale.*

**credits:**

photo by Studio Pi-Tre

## Table of dimensions / *Tabella dimensionale*



N° 443.090.V

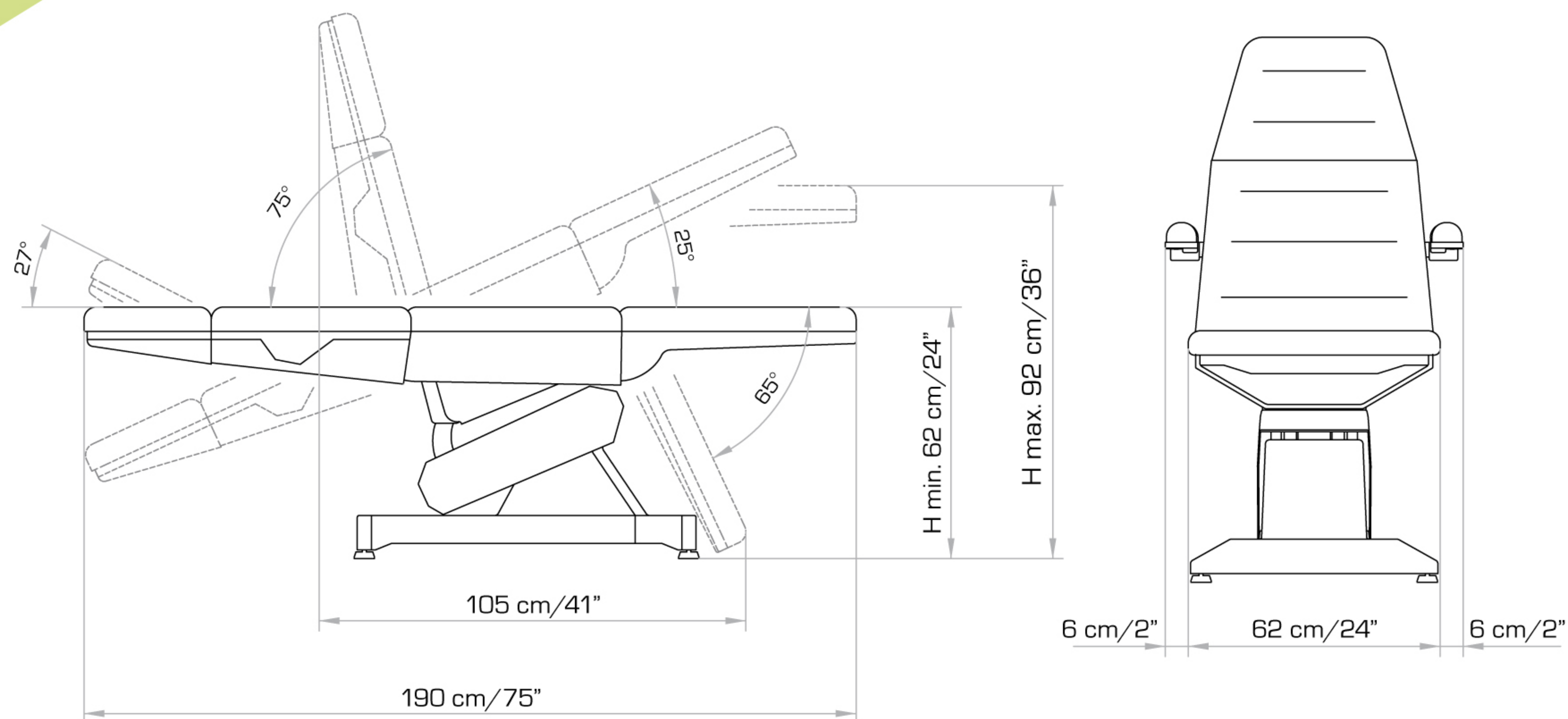

Lemi 4 is CE conformed and is manufactured in accordance with  
European Directives: 93/42/CE (class I); 2006/42/CE; 2004/108/CE;  
CEI EN 60204-1:2006-09; UNI EN 12100-1-2

*Lemi 4 è a norme CE ed è fabbricato in conformità alle seguenti Direttive Europee:  
93/42/CE (classe I); 2006/42/CE; 2004/108/CE;  
CEI EN 60204-1:2006-09; UNI EN 12100-1-2*

### Brusaferrì & C S.r.l.

Headquarters / *Sede operativa*: S.P. n. 6 • 26011 Casalbuttano (CR) • Italy  
Tel. +39 0374 363068/69 • Fax +39 0374 363071

[www.lemi.it](http://www.lemi.it) • [info@lemi.it](mailto:info@lemi.it)

### USA Branch:

Lemi USA LLC: 280 Fentress Blvd • Daytona Beach, FL. 32114  
T. 386-239-8433 • F. 386-239-8627

[www.lemiusa.com](http://www.lemiusa.com) • [info@lemiusa.com](mailto:info@lemiusa.com)



**Lemi**<sup>®</sup>  
MADE IN ITALY

**MEDICI-H**  
WWW.MEDICI-H.CZ  
MEDICI-H@MEDICI-H.CZ  
GERSTNEROVA 5, PRAHA 7

+420 233 370 630, +420 233 375 991